

PRODUCT DATASHEET

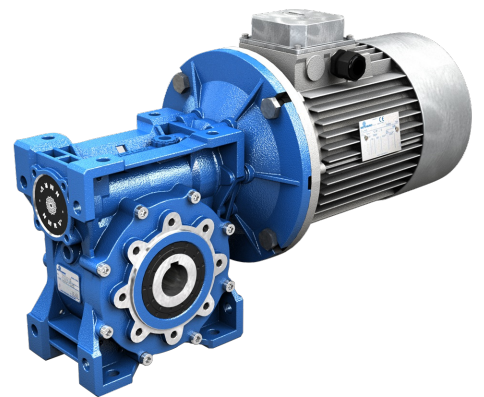

WORMGEARED MOTOR WITH ACCESSORIES/MOTOR

DATE 11.06.2018

CONFIGURATION

CHARACTERISTIC	VALUE
Motor/Inverter Motor	With Motor
Regulations	No
Worm	PAM NMRV
Size	150
Ratio (i)	60,0
Input Dim.	Ø250x28 (IEC100-112 B5)
Hollow Output Shaft Dim.	Ø50
Double-Extended Worm Shaft	No
Mounting Position	B3
Output Flange	No.
Output Shaft	No
Output Cover	No
Torque Arm	No
VI-Output Oil Seal	NBR-Nitrile
VI-Input Oil Seal	ACM-Polyacrylate
VI-Output Bearings	Ball Bearings
VI-Lubrication	Eni Telium VSF 320
Paint	Ral 5010 Blue
Supplier	Motovario
Regulations	CE
Motor	Three-Phase
Size	100
Series	High Efficiency
Poles	4
Electrical Execution	Std (Voltage Tolerance +/- 10%)
Service	S1
Voltage	220/380V
Frequency	50-60 Hz
Power	2,2 kW
Cooling	Self-Ventilated
Mounting Arrangements	B5
Terminal Box	Pos.1
Flange Dim.	Ø250
Shaft Dim. (DE)	Ø28x60
Rear Shaft End (NDE)	No
Insulation Rating	F
Protection Rating	IP55
Thermal Protectors	No
Ambient Conditions	Standard
Heaters	No

CHARACTERISTIC	VALUE
Condensation Drainage	No
Devices	No
Accessories	None
Terminal Box Cover	Aluminium
Fan	Plastic
Fan Cover	Standard
MO-Notes	No

Values expressed in [mm]

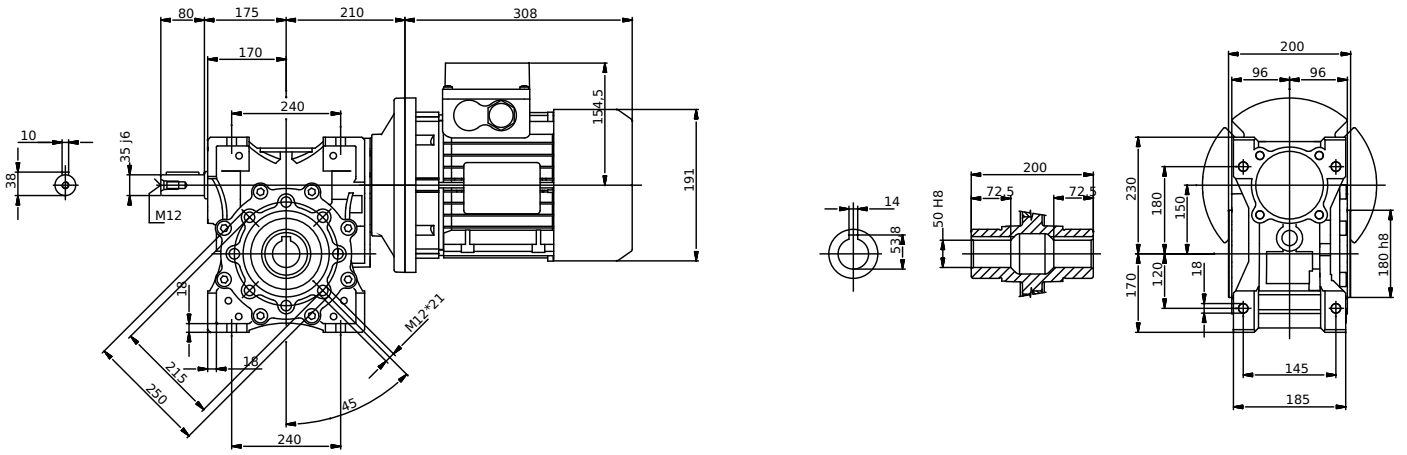

2,20 kW (50Hz)

n2 [rpm]	M2 [Nm]	fs	i	Gear reducer	Motor	Fr2 [N]
24,0	652	1,9	60,00	NMRV150	TH100LA4	13924

2,20 kW (60Hz)

n2 [rpm]	M2 [Nm]	fs	i	Gear reducer	Motor	Fr2 [N]
29,0	536	2,2	60,00	NMRV150	TH100LA4	12926

The mounting position of the gear unit identifies its space orientation. B3 mounting position, as from a technical point of view, ensures lower oil splash, better lubrication and less heating.

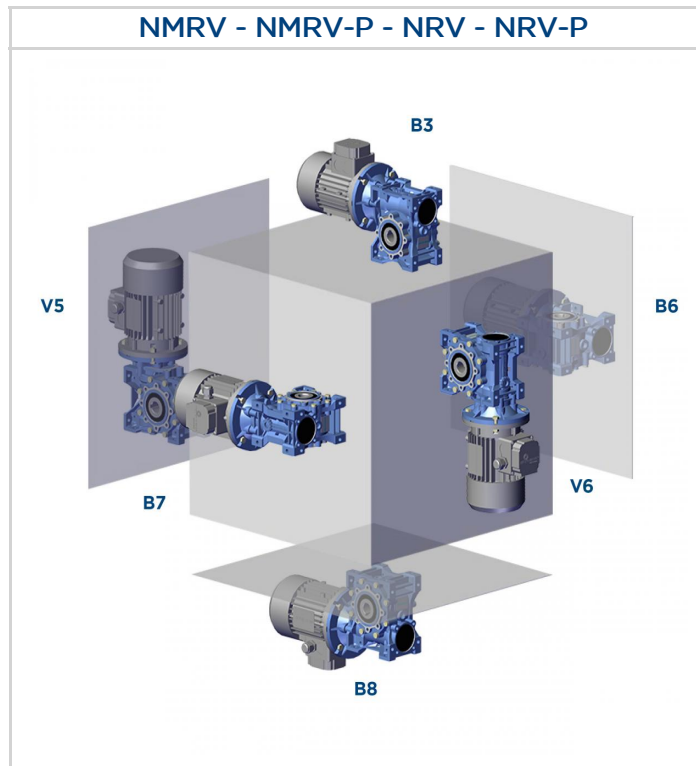

Execution

NMRV/NMRV-P+NMRV/NMRV-P - NRV/NRV-P+NMRV/NMRV-P

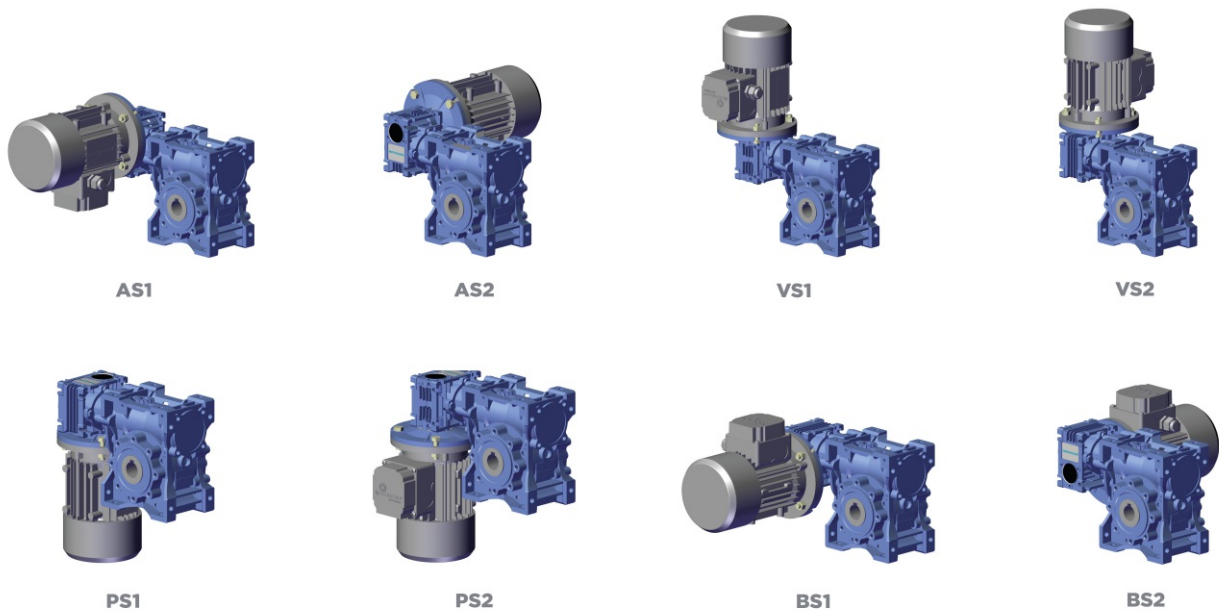

- The gear reducers size 025 - 030 - 040 - 050 - 063 - 075 - 090 - 105 - 110 - 130 - 150 are supplied complete with lubricant for life, synthetic oil, ENI TELIUM VSF. They can be mounted in any position envisaged in the catalogue, except for NMRV 090 - 110 and NRV 075-090-110 for which you must to specify the mounting position.
- For sizes 130 and 150 it is necessary to specify the position, otherwise the gear reducers are supplied with the quantity of oil relating to pos. B3.
- Only reduction units 130 and 150 are fitted with breather, level and oil drainage plugs.
- The pre-stage helical modules are supplied complete with life-long lubricant, synthetic oil, ENI TELIUM VSF. Lubrication is separated from that of the worm gear reducers.

It is recommended, after installation, to replace the closed plug used for transportation with the supplied breather plug.

Quantity of oil in litres -

NMRV	025	030	040	050	130	150
B3	0,02	0,04	0,08	0,15	4,5	7
B8					3,3	5,1
B6-B7					3,5	5,4
V5					4,5	7
V6					3,3	5,1

NMRV-P	063	075	090	110
B3	0,33	0,55	1,15	1,6
B8				
B6-B7				
V5				
V6				

SW	030	040	050	063	075	090	105
B3	0,04	0,08	0,15	0,3	0,55	1	1,6
B8							
B6-B7							
V5							
V6							

HW	HW030		HW040	
	NMRV-P063	NMRV-P075	NMRV-P090	NMRV-P110
B3-B6-B7-B8-V5-V6	0,06	0,09	0,11	0,12

H	A31
B3-B5	0,07

The worm screw rotation is right-handed.

DIRECTION OF ROTATION - HIGH SPEED SHAFT

NMRV - NRV - SW - ISW



MOUNTING POSITION **B3**

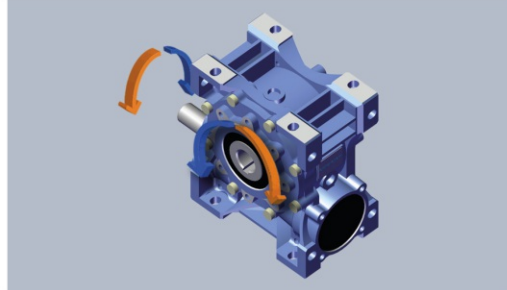

MOUNTING POSITION **B8**

NMRV + NMRV - SW + SW - NRV + NMRV - ISW + SW

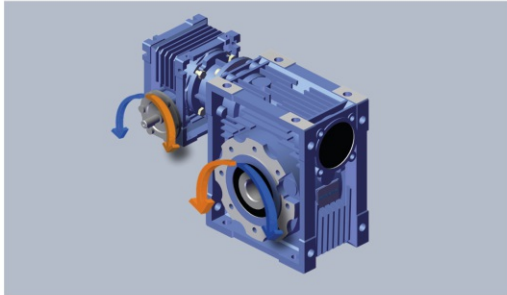

MOUNTING POSITION **AS1**

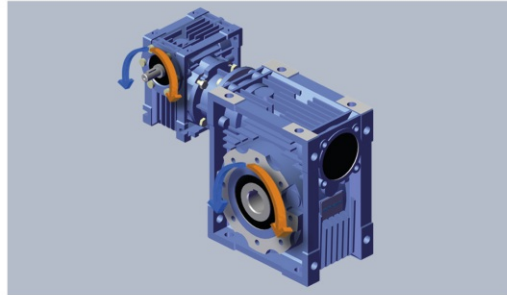

MOUNTING POSITION **BS1**